



KIT





KIT | 4

KIT – Baut Brücken für Ihre Kommunikation

KIT – builds bridges for your communication

KIT – Bouwt de brug voor uw communicatie



freistehend
freestanding
vrijstaand

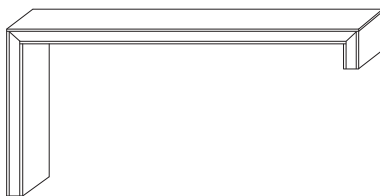

aufgedockt
resting
opgedokt



Wandmontage
wall mounting
wandmontage

Ob kleine Stehbesprechung, Laptop-Präsentation oder kurze Kaffeepause – alles ist möglich. KIT ist in verschiedenen Höhen, Breiten und Tiefen erhältlich. Die Brücke ist als freistehende Lösung genauso praktikabel wie auch als wandgebundenes Element. Dabei ist KIT voll elektrifizierbar und bietet alle relevanten Schnittstellen zur modernen Medienwelt.

Whether small standing conference, laptop presentation or short coffee break – the sky's the limit. KIT is available in different heights, widths and depths. The bridge is feasible, no matter if freestanding solution or mounted element at the wall. KIT allows full electrification and provides every relevant interface to the modern world of media.

Korte stavergadering of laptop presentatie of korte koffiepauze – alles is mogelijk. KIT is compleet bekabelbaar en biedt alle belangrijke aansluitingen voor de moderne mediawereld. KIT is in verschillende hoogtes, breedtes en dieptes verkrijgbaar. Het kan vrijstaand geplaatst worden en is ook als muurverbonden element verkrijgbaar. KIT is compleet bekabelbaar en biedt alle belangrijke aansluitingen voor de moderne mediawereld.





MEETING



Zur Wandmontage an Wänden oder Schränken
For wall mounting at walls or cabinets
Voor wandmontage aan de muur of aan een kast

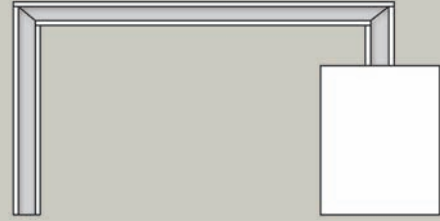

Brücke zum Aufdocken auf Container oder Sideboards
Bridge for resting on containers or sideboards
Brug voor opdokken op ladeblokken of sideboards

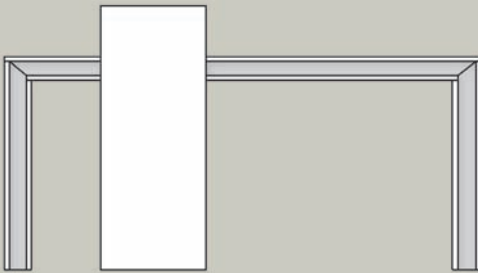

Zwei Höhen von 913 und 1105 mm über Kreuz
Two heights of 913 and 1105 mm crosswise
Twee hoogtes van 913 en 1105 mm kruislings



Brücke mit Schubladenschrank SELECT
Bridge with drawer cabinet SELECT
Brug met SELECT schuifladenkast

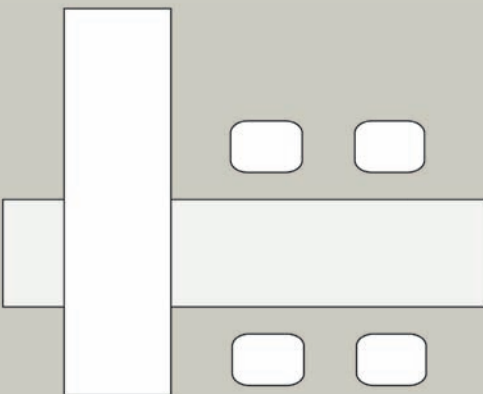

WORKING

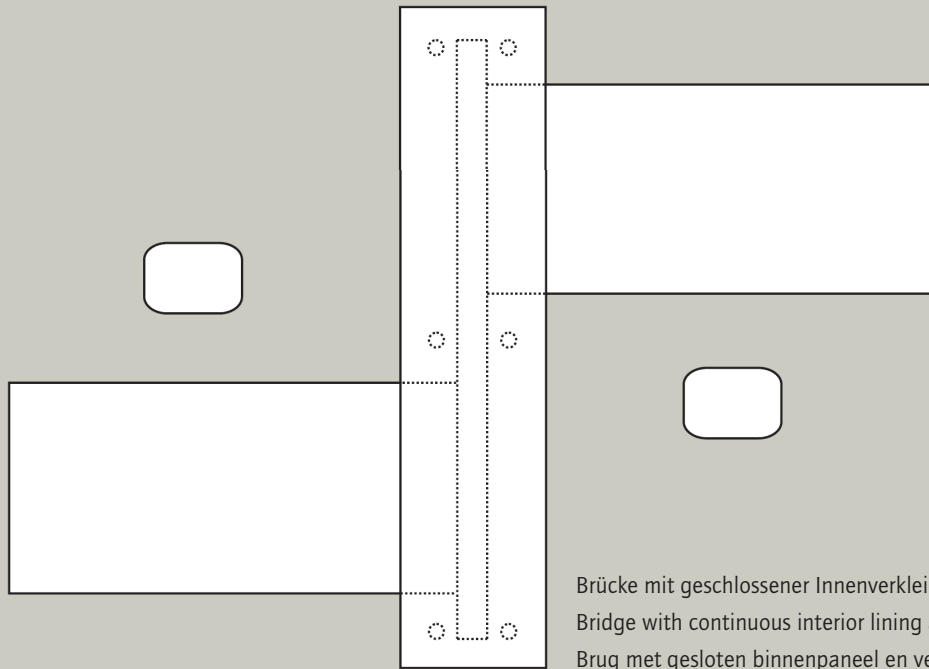

Brücke mit geschlossener Innenverkleidung und Beleuchtung
Bridge with continuous interior lining and lighting
Brug met gesloten binnenpaneel en verlichting



LED-Strahler
LED
LED-licht



Point
Point
Point



Kabeleinlassbuchse
Cable socket
Kabeldoorvoerdp

CATERING

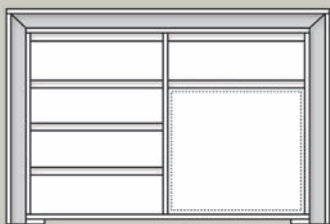

Brücke für Cateringumbau mit Schubladenschrank links und Frontauszug mit Abfallbehälter rechts

Bridge for catering modification with drawer cabinet left and front pull-out with waste bin right

Brug voor cateringombouw met schuifladenkast links en uittrekbaar front met afvalcontainers rechts

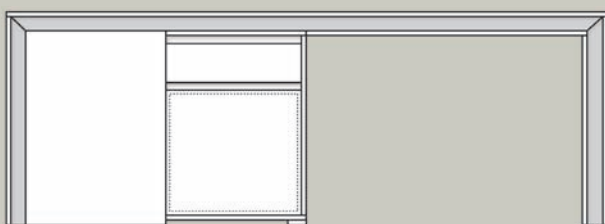

Brücke für Cateringumbau mit Kühlschrank hinter Schiebetür links und Frontauszug mit Abfallbehälter rechts

Bridge for catering modification with fridge behind sliding door left and front pull-out with waste bin right

Brug voor cateringombouw met koelkast achter schuifdeur links en uittrekbaar front met afvalcontainers rechts

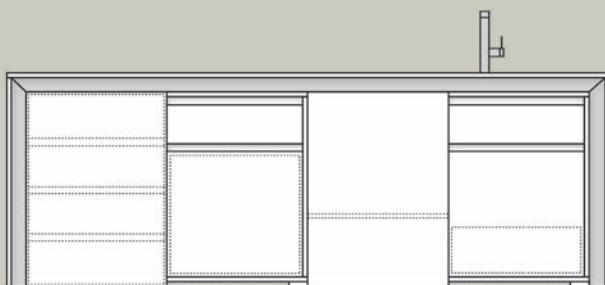

Brücke für Cateringumbau inkl. Oberboden mit Spüle und Armatur

Bridge for catering modification inclusive top board with sink and fittings

Brug voor cateringombouw incl. toplad met spoelbak en kraan

DIMENSIONS

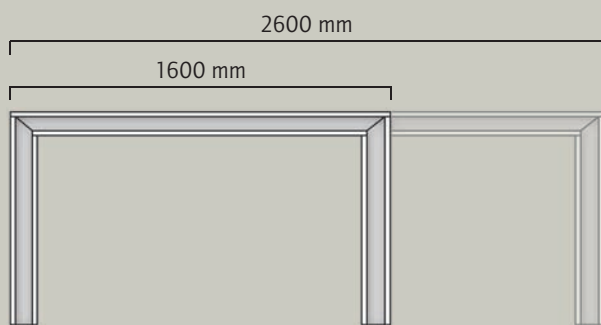

KIT passt sich Ihrem Raum an – mit unterschiedlichen **Breiten** von 1600 bis 2600 mm.

KIT adapts itself to your room – with different **widths** from 1600 to 2600 mm.

KIT past zich aan uw beschikbare ruimte aan – met verschillende **breedtes** van 1600 tot 2600 mm.



Die Brücken gibt es wahlweise mit **Höhen** von 913 oder 1105 mm.

The bridges are optionally available in **heights** of 913 or 1105 mm.

De bruggen zijn op de **hoogte** van 913 of 1105 mm verkrijgbaar.

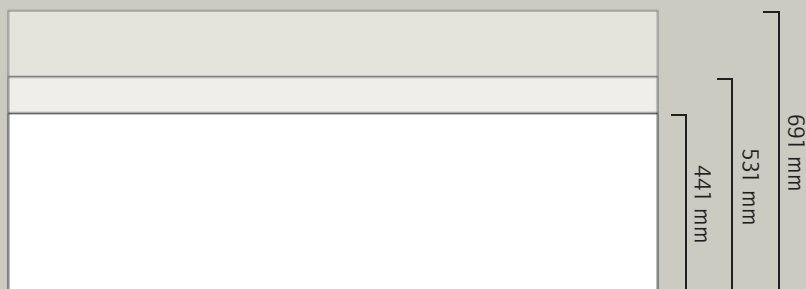

Ausreichend Platz bieten die drei wählbaren **Tiefen** von 441, 531 und 691 mm.

The selectable **depths** of 441, 531 and 691 mm provide sufficient space.

Voldoende ruimte bieden de drie verschillende **dieptes** van 441, 531 en 691 mm.





Multifunktionale Raumlösung
Multifunctional space solution
Multifunctionele ruimteoplossing

11 | KIT

Ob Nebeneinander oder Gegenüber – KIT bietet ausreichend Platz für einen intensiven Dialog und wird durch die Integration von Funktions- und Multimediaelementen zum modernen Kommunikationsmöbel.

Whether next to or opposite – KIT provides enough space for an intense dialogue and becomes, integrating functional and multimedia elements, modern communication furniture.

Naast- of tegenover elkaar – KIT biedt voldoende ruimte voor een intensieve dialoog en wordt door de integratie van functie- en multimedia-elementen een modern communicatiemeubel.

Sie haben die *Wahl*
 It's *your choice*
 U hebt de *keuze*

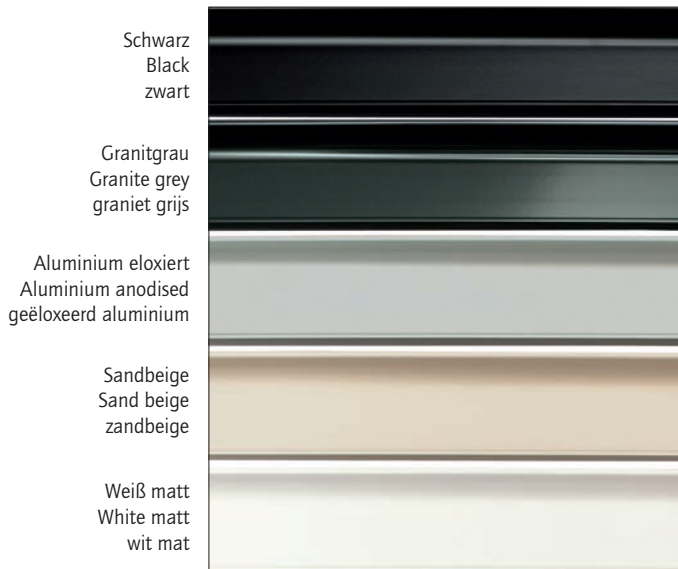
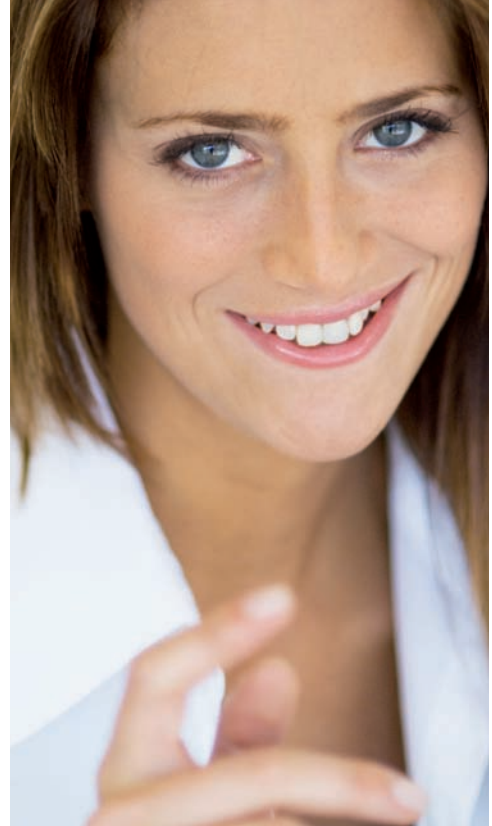

Farben der Greifraumprofile
 Colours of the spatial grip profiles
 Kleuren van de greepprofiel

Sockelfüße · Base · Hoeksokkels



Glasdrehüren und Glasboden
 Glass hinge doors and glass shelf
 Glasdraaideuren en glazen topbladen

Dekore · Decors · Decors

 <p>Ahorn Maple ahorn</p>	 <p>Buche gedämpft Beech muted gedempt beuken</p>	 <p>Birnbäum Pear peren</p>	 <p>toskan. Nussbaum Tuscan walnut toskaans noten</p>	 <p>Teak Rubin Teak ruby teak rubin</p>
 <p>Merano</p>	 <p>Malaga Eiche Malaga oak malaga eik</p>	 <p>Zebrano</p>	 <p>Akazie Acacia acacia</p>	 <p>Nussbaum natur Natural walnut noten natuur</p>
 <p>Superweiß Super white superwit</p>	 <p>Grau perl Grey pearl Grijs parel</p>	 <p>Hanf perl Hemp pearl hanf parel</p>	 <p>Sandbeige Sand beige zandbeige</p>	 <p>Aluminium geschliffen Aluminium polished geslepen aluminium</p>
 <p>Anthrazit perl Anthracite pearl antraciet parel</p>	 <p>Vulkan schwarz Volcano black vulkaan zwart</p>	 <p>Olivgrün Olive green olijfgroen</p>	<p>Plattenstärke: 19 mm Tabletop thickness: 19 mm Plaatdikte: 19 mm</p>	

Erfahrungsgemäß können Druckfarben nicht die Brillanz der Dekor- und Gestellfarben wiedergeben. Gern wird Ihr Händler Ihnen Originalmuster vorlegen.

Experience has shown that the printed colors cannot reflect the brilliancy of the decoration and frame colors. Your dealer will be happy to present original samples.

Uit ervaringen blijkt dat de afgedrukte kleuren de brilliancy van decor- en onderstelkleuren niet volledig weergeven. Uw dealer toont u graag de originele kleuren.



Überzeugen Sie sich auf www.palmberg.de von vielen weiteren Lösungen für informelle Kommunikation.

A lot of other solutions for informal communication you can find at www.palmberg.de

Overtuigt u zich via www.palmberg.nl van de vele overige oplossingen ten aanzien van informele communicatie.





PALMBERG Büroeinrichtungen + Service GmbH
Am Palmberg 9 · D-23923 Schönberg
Tel. +49 (0) 38828-38-0 · Fax +49 (0) 38828-38-136
info@palmberg.de · www.palmberg.de

PALMBERG (Schweiz) AG
Niederlenzerstraße 25 · CH-5600 Lenzburg
Tel. +41 (0) 62-7239191 · Fax +41 (0) 62-7239292
info@palmberg.ch · www.palmberg.ch

PALMBERG Büroeinrichtungen + Service GmbH
Rietveldenweg 47 · NL-5222 AP 's-Hertogenbosch
Tel. +31 (0)4 11-6895 22 · Fax +31 (0)4 11-6894 79
info@palmberg.nl · www.palmberg.nl

PALMBERG-Produkte werden ausschließlich über autorisierte Fachhändler angeboten, um Ihnen ein Höchstmaß an Service und Bürokompetenz zu gewährleisten. Wenden Sie sich daher an: